

East Dunbartonshire Council

# Sustainable Transport Planning Guidance

August 2022



sustainable thriving achieving

**East Dunbartonshire Council**

[www.eastdunbarton.gov.uk](http://www.eastdunbarton.gov.uk)

# Contents

<b>1. Introduction</b>	<b>3</b>
<b>2. Transport Assessment</b>	<b>5</b>
<b>3. Parking and Cycle Standards</b>	<b>9</b>
<b>Electric Vehicle Charging Infrastructure Standards</b>	<b>18</b>
<b>Appendix 1 - Transport Assessment Scoping Form</b>	<b>20</b>
<b>Appendix 2 - Vehicle and Cycle Parking Dimensions</b>	<b>25</b>
<b>Appendix 3 - Maps identifying the Public Transport Access Areas and defined Town Centres</b>	<b>31</b>
<b>Appendix 4 - Glossary</b>	<b>37</b>

# 1. Introduction

This planning guidance is intended to support implementation of the East Dunbartonshire Local Development Plan (LDP). The relationship between the LDP, Supplementary Guidance and Planning Guidance is established in Scottish Government Circular 6/2013, and summarised below.

## LDP

### Purpose and Scope

Sets out the Council's policies for the development and use of land, including community strategies which identify opportunities for development, for the period up to ten years from adoption.

This guidance supports LDP 2017 and LDP2. This guidance refers to policies in LDP2 as the Council's up to date policy position.

## Supplementary Guidance

- Developer Contributions
- Design and Placemaking
- Green Infrastructure and Green Network
- Frontiers of the Roman Empire (Antonine Wall) World Heritage Site

### Purpose and Scope

Supplementary Guidance is statutory as it forms part of the development plan, and has that status for decision making. It is limited to the provision of further information or detail in respect of policies or proposals set out in the LDP. SG will be adopted with the LDP and lasts for the period of the Plan.

## Planning Guidance

### Purpose and Scope

Non-statutory planning guidance may be used to provide detail on a range of subject areas. This form of guidance should not be termed Supplementary Guidance and will not form part of the development plan. However, adoption of this guidance by the Council gives it formal status, meaning that it may be a material consideration in decision making. Planning guidance can be updated as required and without the need for scrutiny by Scottish Ministers. Such updates are normally required where a specific issue arises during the period of the plan.

## Policy Context

Local Development Plan 2 Policy 11 – Transport adopts an integrated approach to development, land use and transport, and supports the enhancement of a sustainable transport system that will facilitate economic growth and fulfil the area’s development needs. New developments require to be attractive places that are well served by high quality walking and cycling infrastructure which link into frequent and accessible public transport services to ensure that a range of sustainable, practical and healthy travel options are enjoyed by people who visit, live or work in East Dunbartonshire. This is achieved in line with Scottish Planning Policy by reducing travel through directing development to sustainable locations, integrating the Sustainable Travel Hierarchy into development and the provision of transport infrastructure through development proposals.

The National Transport Strategy: ‘Protecting our climate and improving lives’, published in 2020, includes within its vision that “We will have a sustainable, inclusive, safe and accessible transport system, helping deliver a healthier, fairer and more prosperous Scotland for communities, businesses and visitors”. The National Transport Strategy also includes taking climate action and improving health and wellbeing as priorities for Scotland’s transport system over the next twenty years. Transport and land use are intrinsically linked and the table below shows how the Council’s planning policy covers planning considerations for transport.

	Planning consideration	Overarching Policy	Further detail
Locating development	Location of development in sustainable locations through appraisal of cumulative and individual effects of development on transport networks and air quality	Policy 1 – East Dunbartonshire Development Strategy	Community Policies Policy 11 – Transport
	Role of wider transport planning in serving new development	Community Policies 2 - 8	Local Transport Strategy
Individual development proposals	Road layout and design	Policy 10 – Design and Placemaking Policy 11 – Transport	Design and Placemaking Supplementary Guidance
	Review of implications for air quality	Policy 11 – Transport	Air Quality Planning Guidance
	Review of implications for transport through Transport Assessment	Policy 11 – Transport	Sustainable Transport Planning Guidance
	Parking standards including cycle parking	Policy 11 – Transport	Sustainable Transport Planning Guidance
	Electric vehicle charging infrastructure	Policy 11 – Transport	Sustainable Transport Planning Guidance

This Sustainable Transport Planning Guidance will therefore add greater detail to Policy 11 on

- Transport Assessment requirements as part of detailed development proposals
- Parking standards for all new development, including cycle parking
- Electric vehicle charging infrastructure requirements

## 2. Transport Assessment

Once detailed development proposals are known, the planning authority will require applicants to consider the implications for the surrounding transport network. This is achieved through a process known as Transport Assessment, set within the context of Local Development Plan 2.

Transport Assessment will assist the planning authority to determine what the implications will be on the surrounding transport network resulting from a proposed development. A **Transport Assessment** is a detailed analysis of the proposal, existing transport connections, travel flows expected to occur once the development is in place and the identification of measures required to support more sustainable travel to/from the development.

A Transport Assessment should be accompanied with a Travel Plan. A **Travel Plan** is a site specific package of practical measures that are put in place to encourage journeys to be made to/from the development in line with the Sustainable Travel Hierarchy, and therefore in line with Policy 11 of LDP2.

Where it is considered that the proposed development is unlikely to have significant implications for the local transport network but the implications are not negligible, a Transport Statement may suffice for the requirements of Transport Assessment. A **Transport Statement** is a simpler piece of work which outlines the current transport connections in the local area, as well as proposed measures to improve sustainable travel to/from the site. Detailed accessibility analysis and impacts on traffic are not required within a Transport Statement.

### The Transport Assessment Process

The basic structure of the Transport Assessment Process is outlined in the diagram below. The requirement for a specific application to move through the stages will be decided on a case by case basis through discussions between the developer and planning authority.





## Scoping

### Scoping the requirements for Transport Assessment

Not every development application will require to undertake Transport Assessment. The need for Transport Assessment and the level of assessment required is determined by the likelihood of significant implications for transport resulting from the proposed development.

To assist the planning authority and ensure the Transport Assessment process is as effective as possible, the need for Transport Assessment should be identified as early as possible in the development application process. This should be achieved through the completion of a Transport Assessment Scoping Form – included within Appendix 1. Further information may be required following completion of the Scoping Form.

The planning authority will require particular attention is given to Transport Assessment where:

- The location or use of the site is not consistent with policy contained within Local Development Plan 2
- The location of the site is within close proximity to existing Air Quality Management Areas and Town Centres
- The planning authority has significant concerns about the possible transport impact of the proposed development

Table 1 below sets out indicative criteria which will be used by the planning authority to inform decision making on the level of Transport Assessment required. It should be noted that Transport Assessment is required where a development proposal is expected to have significant transport implications, regardless of size, therefore the final decision on the level of assessment required rests with the planning authority. Development proposals that do not exceed the parameters set out in Table 1 will still be subject to initial scoping to determine any likely requirements for further Transport Assessment.

**Table 1 – Indicative criteria for level of Transport Assessment required**

Land Use	Parameter	Transport Assessment and Travel Plan	Transport Statement
Business / Office	≥ 2000m <sup>2</sup> GFA	✓	
	1000m <sup>2</sup> – 1999m <sup>2</sup> GFA	Scoping to determine	✓
Cinemas and conference facilities	≥ 1000m <sup>2</sup> GFA	✓	
Distribution and warehousing	≥ 10,000m <sup>2</sup> GFA	✓	
Higher and further education	≥ 2,500m <sup>2</sup> GFA	✓	
Industry	≥ 5000m <sup>2</sup> GFA	✓	
	2500m <sup>2</sup> – 4999m <sup>2</sup> GFA	Scoping to determine	✓
Leisure facilities	≥ 1000m <sup>2</sup> GFA	✓	
Parking	≥ 100 spaces	✓	
	20 – 99 spaces	Scoping to determine	✓
Residential	≥ 100 units	✓	
	20 – 99 units	Scoping to determine	✓
Retail	≥ 1000m <sup>2</sup> GFA	✓	
	500m <sup>2</sup> – 999m <sup>2</sup> GFA	Scoping to determine	✓
Stadia	≥ 1500 seats	✓	
Vehicle movements	≥ 100 movements per day	✓	
	≥ 40 movements on A81, A803 (AQMA), A809 (AQMA), A810 routes or any Town Centre in any hour	✓	
	≥ 10 Freight movements per day	✓	

GFA – Gross Floor Area  
≥ - Greater than or equal to

# Assessment

## Guiding Principles of a Transport Assessment

Once the level and scope of Transport Assessment has been agreed, all Transport Assessments will have to follow guiding principles as set out in Transport Scotland's 'Transport Assessment Guidance'<sup>1</sup>. The guiding principles are 'encouraging environmental sustainability' and 'managing the existing transport network'.

### Encouraging environmental sustainability

Policy 11 is clear that new development must prioritise movement to/from development sites in line with the Sustainable Travel Hierarchy, therefore prioritising walking, cycling and onward public transport journeys through development proposals. Transport Assessments must reflect this hierarchy by assessing how people will travel to/from the new development and including practical measures that will make sustainable travel the most attractive and easy option to increase the proportion of journeys made by sustainable modes and reducing the harmful effects of vehicle emissions. This is particularly important in areas around Town Centres and existing Air Quality Management Areas.

### Managing the existing transport network

It is included within Policy 11 that development proposals must be located where there are already existing active travel routes and public transport infrastructure, or where links can be easily delivered. Policy 11 also states that development must not have a detrimental effect on the existing transport network. Transport Assessments must therefore take the existing transport network into consideration and determine how it can be best managed to cope with additional development movements and how these movements can be accommodated by walking, cycling and public transport connections.

## Completing a Transport Assessment

A Transport Assessment must provide information in a suitable form to the planning authority and Transport Scotland (if necessary) to allow the planning authority to use the Assessment in the decision making process and other related considerations such as planning and legal agreements.

All Transport Assessments must follow the process and structure outlined in Section 5 of Transport Scotland's Transport Assessment Guidance. In particular, all Transport Assessments must include the following elements:

1. Consideration and understanding of the existing transport network in the development area
2. An assessment of travel characteristics regarding the new development
3. A description of measures which are being adopted to influence travel to/from the site
4. A description of the transport impacts of the development in a dynamic network and how these will be addressed.

This process will be an iterative one for larger developments with regular discussions between the developer and planning authority leading to refinement of design layout and connectivity priorities to ensure the site delivers on the Sustainable Travel Hierarchy.

<sup>1</sup> Transport Assessment Guidance, 2012

## Travel Planning

Travel Plans are a package of site specific measures to prioritise and promote sustainable travel to/from the site. They can be used in a wide variety of settings but must be bespoke to the development site and proposal relevant to the site.

A Travel Plan Framework should be agreed by the developer and planning authority at the planning application stage which will set out how travel planning will be incorporated into the development proposal and outline measures and targets included within the Transport Assessment.

A more detailed Travel Plan should then appear within the Transport Assessment or as an accompanied document, outlining how the results of the Transport Assessment can in turn be used to provide practical measures intended to support Policy 11 and prioritise movements to/from the site in line with the Sustainable Travel Hierarchy. Travel Plans are also live documents and should ensure that they remain up to date to inform users of the latest information on sustainable travel choices.

The Travel Plan should focus on meeting mode share targets as outlined within the Transport Assessment. Measures included within the Travel Plan must therefore be practical and realistic but which will make a real impact and focus on reducing the level of vehicle travel between the site and destinations including schools, town centres and associated facilities.

The planning authority and applicant can enter into planning obligations to ensure mode share targets and measures included within the Travel Plan are agreed and can be implemented/enforced if required.

More information on the content and delivery of Travel Plans can be found in Section 6 of Transport Scotland's Transport Assessment Guidance.

## Monitoring

Monitoring of Travel Plans and the development's travel behaviour once the development is in place is an important tool for learning for the future as well as allowing both parties an opportunity to assess how planning obligations are being met. Monitoring can include a review of the success of reaching the identified mode share targets and the implementation of the measures included within the Travel Plan.

The obligation on collecting information to inform the monitoring will be placed on the developer and negotiated conditions under which monitoring will take place will be set out as part of agreements made at the planning application stage. To assist with this, a monitoring framework for the Travel Plan should be included within the Travel Plan Framework and Transport Assessment documents.



### 3. Parking and Cycle Standards

This section sets out the vehicle parking and cycle parking standards which will be applied for new development in East Dunbartonshire. This section and standards will be applied in line with Policy 11 – Transport and specifically the requirement to prioritise travel to/from development sites in line with the Sustainable Travel Hierarchy. The standards will therefore be applied to minimise car travel in favour of more sustainable modes of travel, this includes setting maximum standards in line with national guidance and considering the accessibility of sites by public transport. This section provides standards across residential and non-residential land uses.

Land provided for parking supply is by definition a key land use consideration for new development and the effect this land use will have on new and existing communities should be considered early in the design process. New developments should therefore consider the vehicle parking standards alongside Policy 10 – Design and Placemaking to ensure parking supply is provided in such a way that the development accords with all of the design and placemaking principles. Specific consideration must be given principle F when considering the scale and design of vehicle parking to help reduce use of the car by prioritising pedestrians, cyclists and public transport services. Further information relating to the size and requirements of parking spaces is included within Appendix 2.

Policy 11 also requires new development sites to provide electric vehicle charging infrastructure. Specific standards for electric vehicle charging infrastructure is included within the next section but it should be noted at this stage that electric vehicle spaces is not additional parking capacity but should be provided within spaces already required within the vehicle parking standards in this section.



## Residential Parking Standards

Minimum levels of vehicle and cycle parking standards for residential development is detailed in table 2 below. Different standards are specified by residential type and size (by number of bedrooms). The minimum number of spaces required by type and house size is split into either allocated or unallocated provision.

The evidence for car ownership in East Dunbartonshire for flats shows a significant percentage of people who live in flats do not own a car or van and only a small percentage of this group own two or more cars or vans. Preferred use of unallocated provision will therefore limit the land being provided to people in flats who will not make use of this and can be used by the expected small percentage of flat owners who will have two or more cars or vans. Given the current evidence on car ownership for flats in East Dunbartonshire, it is expected that this unallocated provision will also likely be acceptable to provide capacity for visitor parking in addition to permanent residents parking.

The vehicle parking standards set out in this section will be applied across the authority area. However, deviation from the standards may be acceptable in areas defined as having an appropriate level of public transport accessibility or located within a town centre. This approach is in order to encourage more sustainable modes of travel to/from the development site in line with Policy 11 and NPF4. The planning authority will consider this approach where development is proposed to be situated within a defined Public Transport Access Area or defined Town Centre. Maps identifying the Public Transport Access Areas and defined Town Centres is included within Appendix 3.

A Public Transport Access Area is defined as being within 10 minutes walking distance (800m) of a rail station or within five minutes walking distance (400m) of a bus stop which is served by a minimum of six services in the morning or evening peak hours of travel.

**Table 2 – Minimum levels of vehicle and cycle parking standards for residential development**

Land Use	Minimum Car Spaces			Minimum Cycle Spaces	
	Number of bedrooms	Allocated	Unallocated		
Flats (inc. retirement flats)	All	1	+	0.25	1 secure space (see Appendix 2) per unit unless garage or individual fenced off back garden with direct path access which conforms to at least the garden area standards is provided.
		0	+	1.25	
Detached, semi-detached and terraced Houses	1	1	+	0.25	
		Garage	+	1.25	
	2 or 3	2	+	0.1	
		1 + Garage	+	0.25	
4 or more	3	+	0.1		
	2 + Garage	+	0.25		
Affordable Homes	1	1	+	0.1	
		0	+	1.1	
	2	1	+	0.25	
		0	+	1.25	
	3 or more	1	+	0.5	
		0	+	1.5	
Other residential types					

**Table 2 – Minimum levels of vehicle and cycle parking standards for residential development (contd)**

Land Use		Minimum Car Spaces	Minimum Cycle Spaces
Special Needs		1.0 per warden + 0.75 per unit + 0.5 disabled per unit	1 Per Warden + visitor as appropriate
Sheltered Housing	Resident warden and communal facilities	1 per warden/ staff member + 0.5 per unit + 0.25 disabled per unit	1 Per Warden + 1 per 10 units (visitor)
	Remote warden & no communal facilities	1 per warden/ staff member + 0.65 per unit + 0.25 disabled per unit	
Student Accommodation		1 per Warden + 1 per 5 Beds	1 secure per bed (staff and residents). 1 per 10 residents for visitors.

**Table 3 – Maximum levels of vehicle and minimum levels of cycle parking standards for residential institutions**

Land Use	EDC Maximum Car Spaces			EDC Minimum Cycle Spaces
	Operational Parking (Required)	Defined Towns and Public Transport Access Areas	Elsewhere	Authority
<b>Residential Institutions(Class 8)</b>				
Care Home (e.g. Elderly/Nursing Homes)	Assess on Merit with Provision for Ambulances and minibus	1 per 3 bedrooms (Staff and Visitor)	1 per 2 bedrooms (Staff and Visitor)	1 + 1 per 20 staff (Staff), 1+ 1 per 20 beds (Visitor)
Hospitals		Assess on Merit. Recommended: 1.0 per 3 staff 1.0 per 3 beds	Assess on Merit. Recommended: 1.2 per 3 staff 1.2 per 3 beds	

**Notes**

Either choose the top or bottom line for Allocated or Unallocated car parking spaces for each residential unit, do not mix and match. For example a 1 bedroom flat could have 1 allocated space and 0.25 unallocated spaces or 1.25 unallocated spaces.

Disabled provision in shared car parks and flats is now standard, please refer to the Speciality Parking Standards table 4 unless specified.

If the only allocated space available to a unit is an individual garage then it is required to match the disabled size standard. See the disabled discussion above.

Electric vehicle parking is now also a general requirement for residential properties, please refer to Section 4.

## Non-residential parking standards

Annex B of Scottish Planning Policy sets national maximum parking standards for new non-residential development. The Council has adopted these national standards for local use. Scottish Planning Policy also states that local standards should support the viability of town centres. The standards set out below therefore cover the national maximum parking standards and local standards for defined town centres. In addition, in order to support the implementation of Policy 11 and encourage more journeys to be made by sustainable travel, the Council also includes the Public Transport Access Areas within the standards set out below. The standards have been categorised by Class as defined within The Town and Country Planning (Use Classes) (Scotland) Order 1997.

**Table 4 – Maximum levels of vehicle and minimum levels of cycle parking standards for non-residential development**

Land Use	EDC Maximum Car Spaces			EDC Minimum Cycle Spaces
	Operational Parking (Required)	Defined Towns and Public Transport Access Areas	Elsewhere	Authority
<b>Shops (Class 1 and Sui Generis)</b>				
Food Retail Outlets (>1000m <sup>2</sup> GFA)	Assessed Individually	6.5 spaces per 100m <sup>2</sup> GFA (Includes Staff)	7.1 spaces per 100m <sup>2</sup> GFA (Includes Staff)	1 + 1 per 800m <sup>2</sup> (Staff), 1 + 1 per 800m <sup>2</sup> (Visitor)
Non-Food Retail Outlets (>1000m <sup>2</sup> GFA)	1 loading bay per 1,000m <sup>2</sup> GFA	4.5 per 100m <sup>2</sup> GFA (Includes Staff)	5.0 per 100m <sup>2</sup> GFA (Includes Staff)	
Food/Non-Food Retails (<1000m <sup>2</sup> GFA)	Assessed on Merit	6.5 per 100m <sup>2</sup> GFA (Includes Staff)	7.1 per 100m <sup>2</sup> GFA (Includes Staff)	
<b>Motor Trade</b>				
Vehicle Display Area	-	2.5 per 100m <sup>2</sup> + 1 per Staff	3.0 per 100m <sup>2</sup> + 1 per Staff	1 + 1 per 20 staff (Staff), 2 (Visitor)
Spares	-	4.0 per 100m <sup>2</sup> + Staff	4.0 per 100m <sup>2</sup> + Staff	
Servicing	-	4.0 per bay + 1 per 3 Staff	4.0 per bay + 1 per 2 Staff	
Tyre Exhaust Centres	5 Queue Spaces	2.0 per bay + 1 per 3 Staff	2.0 per bay + 1 per 2 Staff	
Manual Car Wash		5.0 Queue Spaces + 1 per 3 Staff	5.0 Queue Spaces + 1 per 2 Staff	1 + 1 per 20 staff (Staff).
Automatic Car Wash		5.0 Queue Spaces + 1 per 3 Staff	5.0 Queue Spaces + 1 per 3 Staff	
Scrapyards	-	2.0 spaces + 1 per 3 Staff	2.0 spaces + 1 per 2 Staff	1 + 1 per 20 staff (Staff), 2 (Visitor)
Petrol Filling Stations (Shop Assessed Separately)	-	1.0 per 3 peak staff	1.0 per 2 peak staff	1 if station is discrete of other business and attended by staff.
Shops in Established Centres	Assessed on Merit	4.0 per 100m <sup>2</sup> GFA	5.0 per 100m <sup>2</sup> GFA	1 + 1 per 20 staff (Staff), 2 + 1 per 500m <sup>2</sup> (Visitor)
Car Auction Rooms	1 loading bay	5.0 per 100m <sup>2</sup> Display Area + 1 per 3 Staff	5.0 per 100m <sup>2</sup> Display Area + 1 per 2 Staff	1 + 1 per 20 staff (Staff), 2 (Visitor)

Land Use	EDC Maximum Car Spaces			EDC Minimum Cycle Spaces
	Operational Parking (Required)	Defined Towns and Public Transport Access Areas	Elsewhere	Authority
<b>Business, Financial, Professional &amp; Other Services (Classes 2 and 4)</b>				
Banks, Building Societies, etc.	Assessed Individually	5.0 per 100m <sup>2</sup> GFA (Includes Staff)	6.0 per 100m <sup>2</sup> GFA (Includes Staff)	1 + 1 per 100 m <sup>2</sup> (Staff), 1 + 1 per 400m <sup>2</sup> (Visitor)
<b>Offices</b>				
>2500m <sup>2</sup> GFA	1 off street loading bay (Can be shared with a drop off area)	1 per 30m <sup>2</sup> (Includes Staff)	1 per 30m <sup>2</sup> (Includes Staff)	1 + 1 per 200m <sup>2</sup> (Staff), 1 + 1 per 500m <sup>2</sup> (Visitor)
<2500m <sup>2</sup> GFA		4 per 100m <sup>2</sup> (Includes Staff)	4.5 per 100m <sup>2</sup> (Includes Staff)	
<200m <sup>2</sup> GFA		6.0 per 100m <sup>2</sup> (Includes Staff)	7.0 per 100m <sup>2</sup> (Includes Staff)	
<b>Food and Drink (Class 3)</b>				
Restaurants	Assessed on merit	6.0 per 100m <sup>2</sup> + 1 per 3 Staff	8.0 per 100m <sup>2</sup> + 1 per 2 Staff	1 + 1 per 200m <sup>2</sup> (staff),
Pubs/Bars	Assessed on merit	3.0 per 100m <sup>2</sup> + 1 per 3 Staff	5.0 per 100m <sup>2</sup> + 1 per 2 Staff	1 + 1 per 100m <sup>2</sup> public floor area (Visitor)
Bowling Alleys	-	2.0 per Bowling Lane + 1 per 5 lanes (Staff)	2.0 per Bowling Lane + 1 per 6 lanes (Staff)	2 (staff), 1 per 4 lanes (Visitor)
Take-Away	Assessed on merit	2.0 per 100m <sup>2</sup> + 3 Staff	3.0 per 100m <sup>2</sup> + 4 Staff	2 (staff) + 2 (visitor)
Drive-Through Restaurants	1 loading bay	7.0 per 100m <sup>2</sup> + 1 per 3 Staff	10.0 per 100m <sup>2</sup> + 1 per 2 Staff	2 (staff) + 2 (visitor)
<b>General Industrial (Class 5)</b>				
<b>Industrial Premises</b>				
>200m <sup>2</sup> GFA	1 loading bay up to 500m <sup>2</sup> GFA	2.0 per 100m <sup>2</sup> (Includes Staff)	2.0 per 100m <sup>2</sup> (Includes Staff)	1 + 1 per 700m <sup>2</sup> (Staff), 1 + 1 per 2000m <sup>2</sup> (Visitor)
<200m <sup>2</sup> GFA	2 loading bays between 500m <sup>2</sup> – 2,500m <sup>2</sup> GFA 1 loading bay for each additional 2,000m <sup>2</sup> GFA	3.0 per 100m <sup>2</sup> (Includes Staff)	4.0 per 100m <sup>2</sup> (Includes Staff)	

Land Use	EDC Maximum Car Spaces			EDC Minimum Cycle Spaces
	Operational Parking (Required)	Defined Towns and Public Transport Access Areas	Elsewhere	Authority
<b>Storage and Distribution (Class 6)</b>				
Warehousing (Storage & Distribution)	1 loading bay up to 500m <sup>2</sup> GFA  2 loading bays between 500m <sup>2</sup> – 2,500m <sup>2</sup> GFA	0.7 per 100m <sup>2</sup> (Includes Staff)	1.0 per 100m <sup>2</sup> (Includes Staff)	1 + 1 per 1600m <sup>2</sup> (Staff),  1 + 1 per 6000m <sup>2</sup> (Visitor)
Warehousing (Wholesale Trading)	1 loading bay for each additional 2,000m <sup>2</sup> GFA	Refer to Values in Retail Section	Refer to Values in Retail Section	1 + 1 per 1000m <sup>2</sup> (Staff),  1 + 1 per 2000m <sup>2</sup> (Visitor)
<b>Hotels and Hostels (Class 7)</b>				
Hotel, Boarding House, Bed & Breakfast, Motel, Guest House	Coach spaces required for Hotels with function facilities.  Proprietor spaces based on normal housing requirements 1 loading bay	1.0 per bedroom + 1 per 10 bedrooms (Staff function facilities assessed separately)	1.0 per bedroom + 1 per 15 bedrooms (Staff function facilities assessed separately)	1 + 1 per 20 staff (Staff),  1 + 1 per 20 bedrooms (Visitor). Each Visitor space to be in an individually lockable enclosed shelter or equivalent.
<b>Residential Institutions (Class 8)</b>				
Care Home (Elderly/ Nursing Homes)	Assess on Merit with Provision for Ambulances and minibus	1 per 3 bedrooms (Staff and Visitor)	1 per 2 bedrooms (Staff and Visitor)	1 + 1 per 20 staff (Staff),  1+ 1 per 20 beds (Visitor)
Hospitals		Assess on Merit. Recommended: 1.0 per 3 staff 1.0 per 3 beds	Assess on Merit. Recommended: 1.2 per 3 staff 1.2 per 3 beds	
<b>Non-Residential Institutions (Class 10)</b>				
Day Nursery	Pick up/Drop-off facilities for Parents	0.75 space per peak staff member + Visitor Parking assessed on Merit	1.0 space per peak staff member + Visitor Parking assessed on Merit	1 + 1 per 100m <sup>2</sup> (Staff/ Visitors)
Primary and Secondary School	Pick Up/Drop-off facilities for Buses Loading Bay assessed on Merit  School Travel Plan Required	0.75 space per peak staff member + Visitor Parking assessed on Merit	1.0 space per peak staff member + Visitor Parking assessed on Merit	1 + 1 per 20 staff (Staff),  1 + 1 per 10 pupils (pupil)



Land Use	EDC Maximum Car Spaces			EDC Minimum Cycle Spaces
	Operational Parking (Required)	Defined Towns and Public Transport Access Areas	Elsewhere	Authority
College / University	Loading Bay assessed on Merit	0.5 space per staff member	0.5 space per staff member	1 + 1 per 20 staff (Staff),
	Travel Plan Required	+1.0 space per 15 students	+1.0 space per 15 students	1 + 1 per 10 students (student)

NB Consideration to be given to parking requirements for other public uses of school and college buildings.

#### Non-Residential Institutions (Class 10 and 11)

Public Library	Space for Mobile Library as Appropriate	3.0 per 100m <sup>2</sup> + 1 per 3 Staff	3.0 per 100m <sup>2</sup> + 1 per 2 Staff	1 + 1 per 20 staff (Staff), 1 + 1 per 400m <sup>2</sup> of display space (visitor)
Public Hall/Function Room	Provision for Coaches	5.0 per 100m <sup>2</sup> + 1 per 3 Staff	5.0 per 100m <sup>2</sup> + 1 per 2 Staff	1 + 1 per 20 staff (Staff),
Community Centre	Provision for a mini-bus	5.0 per 100m <sup>2</sup> + 1 per 3 Staff	5.0 per 100m <sup>2</sup> + 1 per 2 Staff	1 + 1 per 100m <sup>2</sup> of public floor area (visitor)
Theatres/ Concert Halls	-	1.0 per 5 seats + 1.0 per 3 peak staff/performers	1.0 per 5 seats + 1.0 per 2 peak staff/performers	1 + 1 per 20 staff (Staff),
Cinemas/Bingo Halls/ Conference Facilities	-	1.0 per 5 seats	1.0 per 5 seats	1 + 1 per 100m <sup>2</sup> of public floor area or 50 seats - whichever is greater (visitor)
Places of Worship	Provision for a Hearse and wedding car	1.0 per 10 seats	1.0 per 10 seats	1 + 1 per 40 seats
Crematoria	Provision for Coaches and Hearse	1.0 per 2 seats + 1 per 3 Staff	1.0 per 2 seats + 1 per 2 Staff	1 + 1 per 20 staff (Staff)
Health Centre / Doctors / Vets / Dentists	Assess on Merit	3.0 per Consulting Room	3.0 per Consulting Room	1 + 1 per 20 staff (Staff), 1+ 0.5 per consulting room (visitor)

#### Non-Residential Institutions (Class 11)

##### Sports Centres

Swimming Baths	-	5.0 per 100m <sup>2</sup> Pool Space + 1 per 3 Staff	7.0 per 100m <sup>2</sup> Pool Space + 1 per 2 Staff	1 + 1 per 20 staff (Staff), 1 + 1 per 80m <sup>2</sup> pool area (visitor)
Snooker Hall	-	0.75 per table + 1 per 3 Staff	1.0 per table + 1 per 2 Staff	1 + 1 per 20 staff (Staff),
Other Facilities	-	1.0 per 2 player at peak + 1 per 3 Staff	1.0 per 2 player at peak + 1 per 2 Staff	1 + 1 per 10 players (visitor)

Land Use	EDC Maximum Car Spaces			EDC Minimum Cycle Spaces
	Operational Parking (Required)	Defined Towns and Public Transport Access Areas	Elsewhere	Authority
Spectators	-	1.0 per 10 seats + 1 per 3 Staff	1.0 per 10 seats + 1 per 2 Staff	1 + 1 per 20 staff (Staff) 1 per 50 spectators (visitor)
Marinas	-	1.0 per berth + 1 per 3 Staff	1.0 per berth + 1 per 2 Staff	1 + 1 per 20 staff (Staff), 1 + 1 per 10 berths (visitor)
Stadia	-	1.0 per 15 seats	1.0 per 15 seats	1 + 1 per 20 staff (Staff),
Leisure	-	1.0 per 22m <sup>2</sup>	1.0 per 22m <sup>2</sup>	1 + 1 per 10 players or 100sqm public floor area - whichever is greater (visitor)
Museums/Public Art Gallery	-	2.0 per 100m <sup>2</sup> public display + 1 per 3 Staff	3 per 100m <sup>2</sup> public display + 1 per 2 Staff	1 + 1 per 20 staff (Staff), 1 + 1 per 200m <sup>2</sup> of display space (visitor)

# Speciality Parking Standards

## Disabled Parking Standards

Disabled Parking is required to be provided in line with the current guidance. These standards are contained within NPF4. This parking is additional to the above requirement.

**Table 5 – Minimum levels of disabled vehicle parking standards**

Land Use	Minimum	
	Up to 200 spaces	Over 200 spaces
Employment Uses	1 space per disabled employee plus 2 spaces or 5% of maximum standard size or actual size (whichever is greater)	6 spaces plus 2% of Maximum Standard Size or actual size (whichever is greater)
Retail, Leisure and Recreation Uses	3 spaces or 6% of maximum standard size or actual size (whichever is greater)	4 spaces plus 4% of maximum standard size or actual size (whichever is greater)
Education (School)	2 spaces or 1 space per 130 pupils (whichever is greater)	
Education (Colleges and University's)	2 spaces or 1 space per 80 students (whichever is greater)	
Residential flats or residencies with shared car parks	5% of maximum standard size or actual size, whichever is greater except when stated as part of the parking standard.	

### Notes

'Maximum standard size' means the maximum car parking allowed for the development under the standards contained within this document. In cases where a larger car park is required than indicated in this document, then that should be treated as the 'Maximum standard size'.

The above assumes that all the parking will be located in single car park. In cases where it is not, then there will normally be a requirement for spaces to be distributed appropriately. In some cases due to car park separation additional spaces will be required.

All spaces shall be located within 45m of the developments door via a step less route except in the most extreme circumstances where advice should be sought at the earliest opportunity.

## Parent and Child Parking Standards

Parent and child parking may be required at some retail developments such as supermarkets. This parking should be provided as part of the standard parking requirement and not additional to it.4.

**Table 6 – Minimum levels of parent and child vehicle parking standards**

Land Use	Minimum	
	Car Park up to 200 Spaces	Car Park over 200 spaces
Retail, Leisure and Recreation Uses	3 spaces or 6% (whichever is greater)	4 spaces plus 4%

# Electric Vehicle Charging Infrastructure Standards

Policy 11 includes a requirement for development to include infrastructure that contributes to the electric vehicle charging network. This requirement is in line with Scottish Government policy and emerging legislation and builds on the Council’s commitment with the Local Transport Strategy 2020-2025 to increase the availability of electric vehicle charging infrastructure. Given the rapidly changing requirements for the electric vehicle charging network, as the Scottish Government develops legislation the requirements in LDP2 Policy 11 are expected to be superseded and standards set out below align with current Scottish Government publications. Should higher standards be set at a national level, these must be applied and this guidance will be updated as soon as practicable.

Table 7 sets out in detail the requirements for electric vehicle charging infrastructure within new development. Individual discussions with the Council’s Traffic and Transport team may be required as part of the development management process to agree specific requirements on an individual basis. It should be understood that the below requirements for dedicated electric vehicle charging spaces is not additional parking capacity but should be provided within spaces already required in Section 3 of this Planning Guidance.

**Table 7 – Required electric vehicle charging infrastructure**

Land Use	Requirement (minimum)
<b>Residential development</b>	
Residential with allocated spaces located within land controlled and within the curtilage of that unit (normally a driveway). Remote or attached unshared residential garages will also attract this requirement.	Each residential unit shall have access to at a minimum a 7kW “slow charge” via a Type 2 with a dedicated socket outlet socketed AC charger operating in mode 3 to BS 7671:2008+A3:2015, BS EN 61851 and any other relevant standards.
Residential (over 10 units) with communal unallocated off-street parking facilities.	<p>At a minimum, 10% of spaces should be provided as active electric vehicle charging spaces. These spaces shall have access to at a minimum a 7kW “slow charge” via a Type 2 with a dedicated socket outlet socketed AC charger operating in mode 3 to BS 7671:2008+A3:2015, BS EN 61851 and any other relevant standards.</p> <p>In these development types, 100% of spaces within communal off-street parking facilities will be required to be passive electric vehicle parking spaces. This means that at the time of development, the necessary infrastructure is put in place to allow the spaces to be prepared for switching to active electric vehicle charging spaces as and when required in the future.</p>



Land Use	Requirement (minimum)
<b>Commercial development with dedicated parking spaces</b>	
<ul style="list-style-type: none"> <li>• Retail (GFA &gt; 500sqm)</li> <li>• Commercial leisure</li> <li>• Hotels (over 20 spaces)</li> <li>• Commercial car parks (over 20 spaces)</li> </ul>	<p>At least two normal bays and one disabled bay or 5% of total (whichever is greater).</p> <p>These bays shall have access to as a minimum 22KW "fast/ rapid charge" via Type 2 AC chargers simultaneously with a minimum of 2 bays. Faster chargers based on the Type 2 or other are also generally acceptable, please discuss with the Transport Officer in such cases.</p> <p>In these development types, 20% of spaces will be required to be passive electric vehicle parking spaces. This means that at the time of development, the necessary infrastructure is put in place to allow the spaces to be prepared for switching to active electric vehicle charging spaces as and when required in the future.</p>
<ul style="list-style-type: none"> <li>• Office and business (GFA &gt; 500 sqm)</li> <li>• General industry (GFA &gt; 1,000 sqm)</li> <li>• Storage and distribution (GFA &gt; 2,000 sqm)</li> </ul>	<p>At least two normal bays and one disabled bay or 5% of total (whichever is greater) (operational spaces and staff parking spaces combined).</p> <p>These bays shall have access to as a minimum 22KW "fast/ rapid charge" via Type 2 AC chargers simultaneously with a minimum of 2 bays. Faster chargers based on the Type 2 or other are also generally acceptable, please discuss with the Transport Officer in such cases.</p> <p>In these development types, 20% of spaces will be required to be passive electric vehicle parking spaces. This means that at the time of development, the necessary infrastructure is put in place to allow the spaces to be prepared for switching to active electric vehicle charging spaces as and when required in the future.</p>

**Note**

All GFA measurements include cumulative development – meaning any reasonably associated prior development, e.g. new development within a retail park.

# Appendix 1 – Transport Assessment Scoping Form

## Transport Assessment Scoping Form



Contact Details		
	Applicant	Consultant
Contact name		
Organisation name		
Address		
Telephone number		
E-mail		

### Part 1a: Initial Screening

Development Details	
<b>1. Location:</b> Include: <ul style="list-style-type: none"> <li>• Address</li> <li>• Settlement area</li> <li>• Location map</li> </ul>	
<b>2. Existing/historical site use</b>	
<b>3. Brief description of development</b> (Attach indicative layout plan and existing layout plan at 1:200 or 1:500 if available)	
<b>4. Development size</b> GFA, Number of units, etc. <i>Please also note if the development is likely to exceed any of the parameters included within Table 1 of Sustainable Transport Planning Guidance.</i>	
<b>5. Phasing of development</b> Provide details on any phasing of development.	
<b>6. Opening year and first full year of development operation</b>	
<b>7. Opening hours of operation of proposed development</b>	
<b>8. Existing land use</b> Provide existing development scales using metrics used in 4.	



## Development Details

### 9. Description of accesses

Provide a basic description of any accesses, including as a minimum their location with respect to other junctions on the road. If possible also include if they are retained from a prior development, what type they are, if any are to be removed and changes to old accesses.

### 10. Public transport access

Is the site centroid, accounting for only all-weather Equalities Act compliant walkable routes, within a 400m walk of the nearest access points to public transport facilities (e.g 2-direction bus stops or a train halt)?

### 11. Information on any existing Travel Plan

## Part 1b: Development Traffic Generation

If Part 1a indicates that there is a requirement for an Assessment or Statement then this section should be completed. Please note that following review of form 1a there may still be a requirement to fill in this section even if 1a indicates that this may not be necessary.

### 1. Please state the anticipated development peak hours (Fill out all that apply).

AM Weekday Peak Hour	
PM Weekday Peak Hour	
Saturday Peak Hour	
Other Peak time	
Other Peak time	

### 2. Please give an indication as to how many vehicle trips will be caused to be made during peak periods.

Vehicle Trips	
Time	Trips (Weekdays)
7am – 10am	
4pm – 7pm	

**3. Please state the anticipated existing and proposed traffic generation Trip Rates<sup>2</sup> if applicable to your traffic generation justification. If additional columns are needed then please fill out copies of this page as required. If you wish to promote the use of discount factors then these should be indicated here.**

	Write description of element & development here					
	AM Peak hr		PM Peak hr		Saturday Peak hr	
	In	Out	In	Out	In	Out
Unit	Trips/	Trips/	Trips/	Trips/	Trips/	Trips/
Existing:						
Total People						
Car						
Vans/deliveries						
Proposed:						
Total People						
Car						
Vans/deliveries						

**4. Please state the existing and anticipated number of trips/ PCU's<sup>3</sup> that will be associated with this development. If additional columns are needed then please fill out copies of this page as required. If you wish to promote the use of discount factors the result of these should be indicated here if appropriate.**

	Write description of element & development here					
	AM Peak hr		PM Peak hr		Saturday Peak hr	
	In	Out	In	Out	In	Out
Unit	Trips	Trips	Trips	Trips	Trips	Trips
Existing:						
Total People						
Car						
Vans/deliveries						
Cars + Vans + Deliveries (PCU's)						
Proposed:						
Total People						
Car						
Vans/deliveries						
Cars + Vans + Deliveries (PCU's)						

<sup>2</sup> A Trip Rate is measure of the number of one-way trips generated by a particular development or element of the development as per an appropriate unit. Typically Trip Rates are expressed as X number of trips of a particular type per 100 square meters of Gross Floor Area

<sup>3</sup> A PCU is a Passenger Car Unit.

5. Please indicate the anticipated mode split . Evidence should be attached and the written justification indicated in the box below.

Write description of element & development here						
Total People	Walking	Cycling	Bus/Train	Car	Other	
Existing:						
Percentage	100%					
Proposed:						
Percentage	100%					

**Traffic Generation Justification**

Please provide justification and evidence for the trip rates and discount factors used. If you are using the Trip Rate Information Computer System to justify your predictions then the TRICS extracts must be compatible with the most recent version of the TRICS Good Practice guide at the time as well as a full breakdown of the output files provided. Please note that poorly produced or justified extracts will likely result in delay and a requirement for re-work.

## Notes:

1. Should traffic capacity analysis be necessary then this will typically be acceptable when conducted using LINSIG 3, TRANYST 14 – 16 and Junctions 9 (ARCADY and PICADY modules). These are the only analysis systems supported in EDC and the use of any other system should be assumed to require the applicant to pay for external consultancy to support the Councils considerations. The Council will in the event procure the consultant and will accept no input on this from the applicant in this process. If any other analysis systems are to be used this should be agreed prior to conduction of work so as to avoid abortive work and costly delays. Please note that this text does not constitute an endorsement of any modelling system or an acceptance that any indicated system is appropriate in your specific case.
2. Please note that all models have to be calibrated and these considerations discussed in any Transport Assessment. Please also note that Junctions 9 uses mean queues not five minute maximum queues and that unequal lane usage at roundabouts will have to be considered where significant.
3. When considering parking please note that there are minimum quality requirements that will apply to the provision all parking including cycle parking. Please also note that failure to consider cycle parking early in a development and preferably in the initial layout plans often leads to avoidable difficulties later on.
4. Our preference for distribution is normally via [scotlandcommute.datashine.org.uk](http://scotlandcommute.datashine.org.uk) or where impractical via a gravity model. We do not generally accept the use of turning flows to provide distributions with the exception of the site access junction when appropriate data is available.

# Appendix 2 – Vehicle and Cycle Parking Dimensions

## Car Parking Dimensions

The minimum dimensions for car parking spaces and garages are as follows below. Substandard spaces will not normally be accepted.

### Garage

All normal garages must have the internal dimensions of 2.9m width and 6m of length. Such space provides for a single car parking bay and one single bicycle bay. Please see Figure 1.1.

Disabled accessible garages are larger, please see the disabled section below. Please note that when a single garage is the only allocated space available to a residential unit then the larger disabled size is required.

### Parking Spaces

Longitudinal bays which have a parking space at one end and open road at the other will have a minimum 5m length. If there is a tapered physical restriction at one end and a parking bay at the other then this length will be increased to 5.5m. Should there be a parking bay at both ends then the minimum length shall be 6m. The width of these bays will normally be 2m but in the case of a high vehicular movement function for instance on A and B class roads, 2.4m will be the minimum. Please see **Figure 1.1**.

A standard perpendicular bay will be 2.5m in width and 5m in length with a 6m aisle. A reduction to 2.4m in width and 4.8m in length with a 6m aisle may be acceptable on a case by case basis. The aisle may only be reduced in width if chevron (angled) bays are used. In such a case please see **Table 1.1** and **Figure 1.2**.

Parking spaces for open use must be located in-front of the footway and adopted. Reserved bays will not be adopted and are to be located behind the footway or within an off street car park.

**Figure 1.1 – Un-allocated longitudinal use and regular garages (Not to scale)**

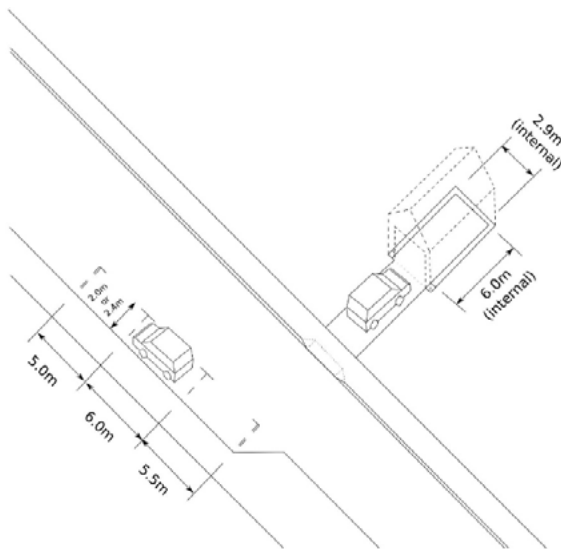

Chevron (angled) bays may only be used on one-way roads. **Table 1.1** shows the minimum aisle strait width and **Figure 1.4** provides an example of this in an off road car park. Please note that wider parking bays may cause the aisle to be narrowed and curving the aisle will cause it to be widened.

**Table 1.1 – Aisle width to be used with chevron parking**

Angle of Parking $\theta$ ( $^{\circ}$ )	Aisle Width W (m)
30 $^{\circ}$	3.2
45 $^{\circ}$	3.4
60 $^{\circ}$	4.0
75 $^{\circ}$	4.7
90 $^{\circ}$	6.0

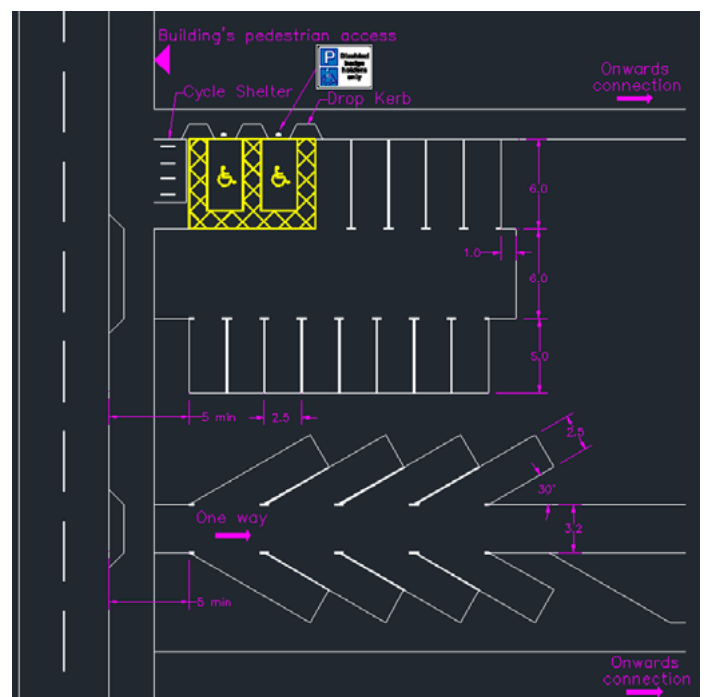

**Figure 1.2 – Off-street parking**

## Disabled parking

In the event of a disabled accessible home being constructed then special care should be taken to ensure that access will match the needs of any disabled user. In construction of typical properties when shared car parking is being used, then there must be some consideration in the form of disabled bays being provided within that shared car park. It will be assumed that when parking is provided within a normal household's curtilage, the owner will modify their own property to make it compliant should that need arise. The only exception would be in the event that the homes only parking is a single space garage. In this case, the garage will comply with the disabled garage requirement.

All disabled bays shall be located within 45m of the door of the development and the route shall be step-less.

### Driveway

The minimum driveway width shall be increased from 2.75m to 3.6m wide, there shall also be a minimum length of 6.6m.

### Garage

The garage will have the minimum dimensions of 4.2m wide by 6m long with a height of 2.6m. If there is a known need for two sided access to the car, then that shall be widened to 5m.

### On-street disabled bays

On-street bays shall generally be parallel. In such cases where perpendicular bays are used, then the normal bays shall be lengthened to match if there is a footway along the top of the bay. The normal dimensions of a parallel bay shall be 6.6m long with a width of 3.6m. The gradient of the bay should, if practical, not be more than 1:50 and the bay or length of bays shall include at least one sensibly located dropped kerb with tactile pavers. If the bay is temporary and if the user is known, then dependent on the need, the near-by dropped kerb may be omitted. Figure 1.3 shows an on-street perpendicular bay.

In difficult circumstances the width of disabled parallel bays can be reduced to 2.7m and then 2.4m. In exceptionally difficult circumstances, the width can be reduced to 1.8m but alternate options will need to be sought out before any such reduction may be agreed. Such a narrow bay may not be acceptable and this will be dependent on the circumstances of the bay.

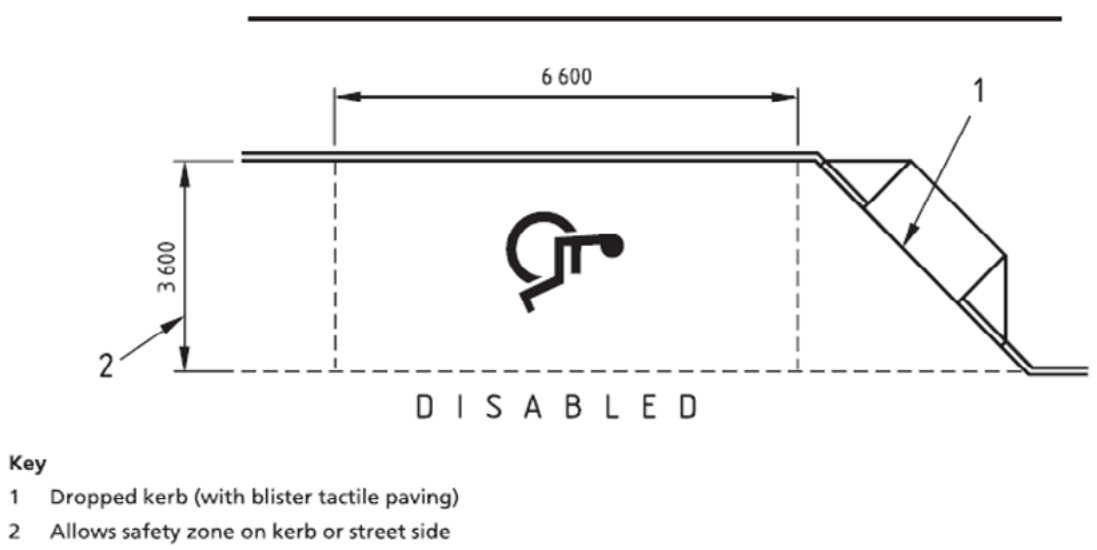

Figure 1.3 – On-street disabled bay



### Off-Street disabled bays

Off-street bays shall generally be perpendicular and always lined in yellow. All perpendicular off street bays will be a minimum of 2.4m by 4.8m and have a 1.2m side strip and in general 1.2m bottom strip. The bottom strip may in difficult circumstances be omitted if traffic is slow and in very low volume but the length of the bay should then be 5m. The gradient of the bay should not be more than 1:50. There shall also be dropped kerb access and this will normally be located at the end of each side strip. **Figure 1.4** shows an off street perpendicular bay.

Parallel off-street disabled bays shall conform to the on-street standard.

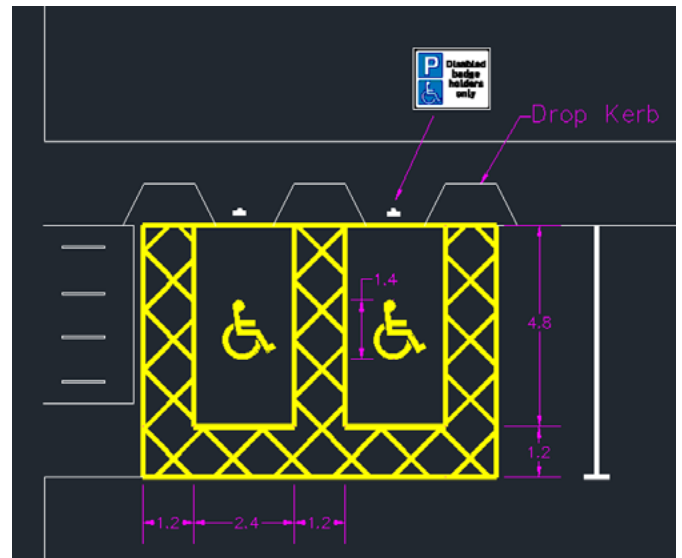

**Figure 1.4 – Perpendicular disabled bay - lower edge of signs to be 1m from the ground**



## Cycle Parking Dimensions & Design

Key principles of cycle parking are set out within *Cycling by Design*, which provides national guidance for permanent cycling infrastructure design on all roads, streets and paths in Scotland.

Cycle parking should be:

- Accessible and convenient, being as close as possible to the destination entrance, prominently located, with plenty of space to get bikes in and out, without steps. Each property should have private and direct access if practical.
- A cycle locker for homes without garages should be provided. This ensures that cycles are:
  - » Secure against theft and vandalism
  - » Covered against the weather
- Cycle lockers are not appropriate for general visitors and cycle parking should be:
  - » Secure against theft and vandalism
  - » Covered against the weather
  - » Have good natural surveillance
- Open stands placed in dark recesses or at the rear of car parks will not be accepted.
- When designing parking facilities the space required for a single parked cycle should be taken as 2m length by 0.75m width by 1.2m high before accounting for access requirements. In difficult circumstances the length can be reduced to 1.8m.
- When two or more bikes are parked beside one another using a Sheffield stand or similar system then they can share space allowing for a much higher parking density.
- When Sheffield stands are provided, bikes can be expected to be parked on both sides of the stands.
- The user assumption will be from a sensible 12 year old to an experienced adult<sup>4</sup>.

In order to be assessed as a parking space, a cycle parking space must meet the minimum size dimensions and quality requirements.



**Image 1.1 – A cycle shelter in a car park**

<sup>4</sup> Sustrans Design Manual, Handbook for cycle-friendly design



**Residential Flats**

Ideally, all units will have private access to their own cycle parking. When designing flats, it can be challenging to provide step-free access and therefore shared shelters can be acceptable. Such shelters should be internal where practical. If they are required to be external, shelters are required to be brick or block built long lasting shelters.

A typical solution for a set of flats would be a cupboard in each ground floor flat with a wall hook to take the bike. The bin store would then be extended, have a party wall fitted and an extra door with a keyed lock. The remaining flats cycle parking storage would then be provided in that space. Alternatively, the cupboards can also be used above the ground floor but this normally requires a sufficiently sized lift to accommodate a bike being loaded normally.

External metal shared shelters should not be used with residences as they do not have the same design life as the rest of the structure and experience with such shelters has indicated that they are not desirable.

The minimum standard for a cycle store is shown in **Figure 1.5**.

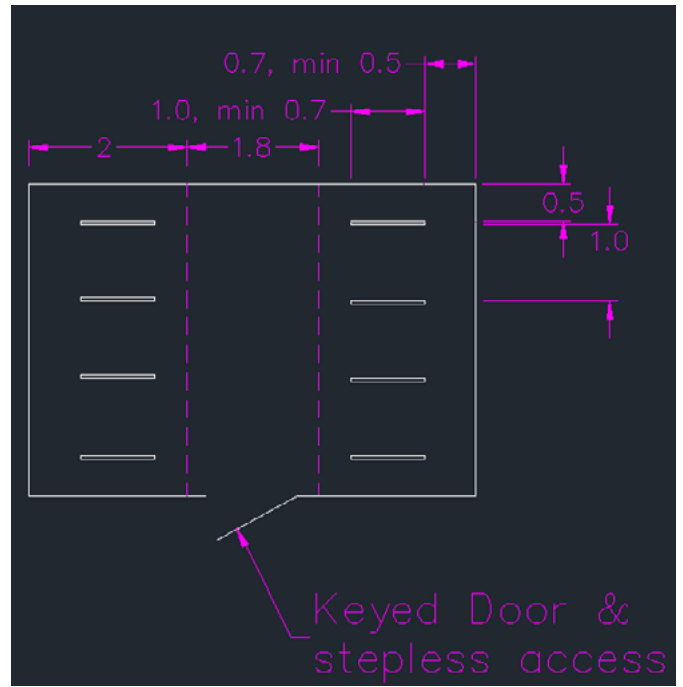

**Figure 1.5 – A shared full enclosed shelter either in an out building or within the development**

**Residential House**

Within a house, the normal solution would be an individually accessible back garden with a shed or a garage meeting the Council’s minimum standards. In such cases where this cannot be met then a cupboard on the ground floor with a wall hook provides the simplest solution. If none of these can be met then a cycle locker will have to be provided within the curtilage of each unit.

**Business and public developments**

Most developments only operate during the day and so only have a requirement for day parking. This can normally be met with the inclusion of an open cycle shelter in the car park by the front door in an over looked location. Such an option is preferable as it also provides simple and efficient parking for both staff, and visitors. An example of such a shelter is shown below in **Image 1.1** and note that there are no overhanging elements that may cause a head injury. Minimum dimensions for these shelters are shown in **Figure 1.6** and **Figure 1.7**.

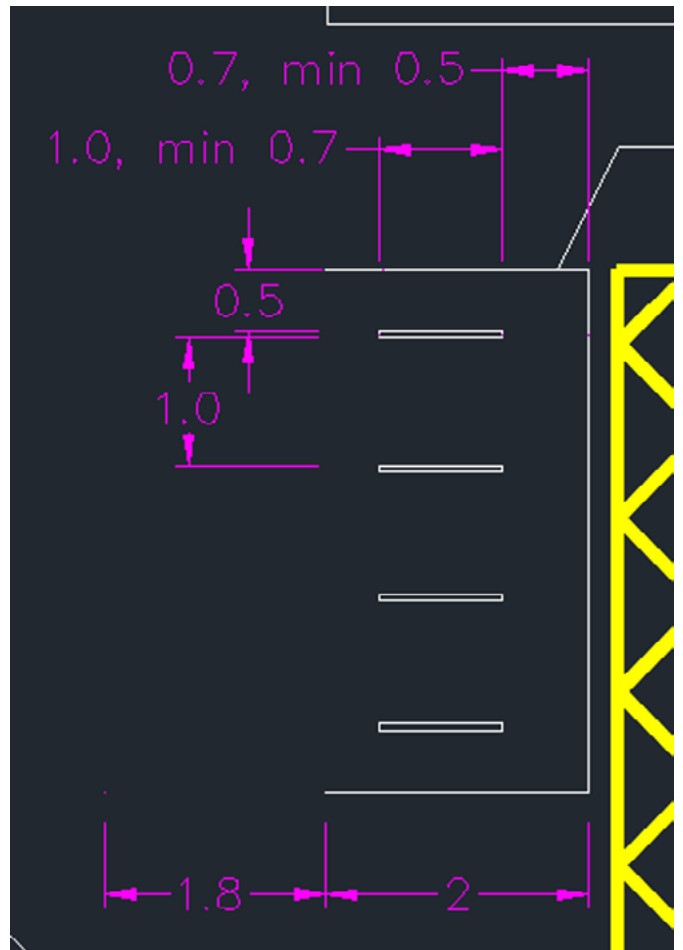

**Figure 1.6 – A shared full enclosed shelter either in an out building or within the development**

With some developments, on footway parking can be practical and is normally provided through a covered recess. **Figure 1.7** shows such an arrangement. Please note that the tapping rail shown only on the right stand is only necessary where visually impaired people may otherwise move into the stand and fail to feel the stand.

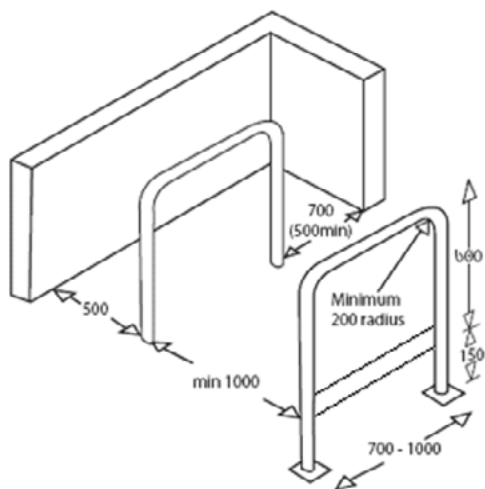

**Figure 1.7 – Two sheffield stands within a covered building recess, the right one shows a tapping rail that may or may not be needed dependent on circumstance**

Visitors by their nature will always require easily accessible parking and so enclosed locked shelters will not be accepted, with the exception of hotels. Hotels should provide cycle lockers (**Figure 1.8** shows a standard arrangement). If there is no practical location available for sufficient open cycle parking shelters then an enclosed locking shelter will normally be accepted for staff in a less desirable but still practical location. A solution would then also have to be sought for visitors which would normally require the provision of parking within the doors of the building.

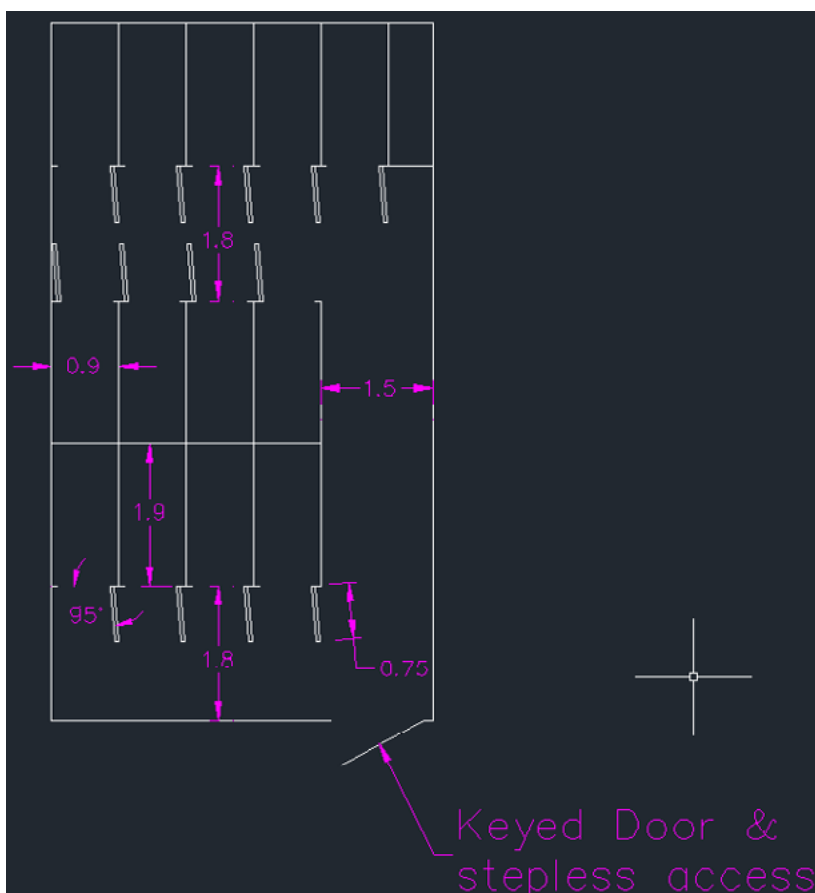

**Figure 1.8 – Typical arrangements for internal cycle lockers (note each locker requires an individually keyed lock and the requirement for a keyed door may be omitted in the correct circumstances)**

## **Appendix 3 – Maps identifying the Public Transport Access Areas and defined Town Centres**

# Public Transport Access Areas within Bearsden

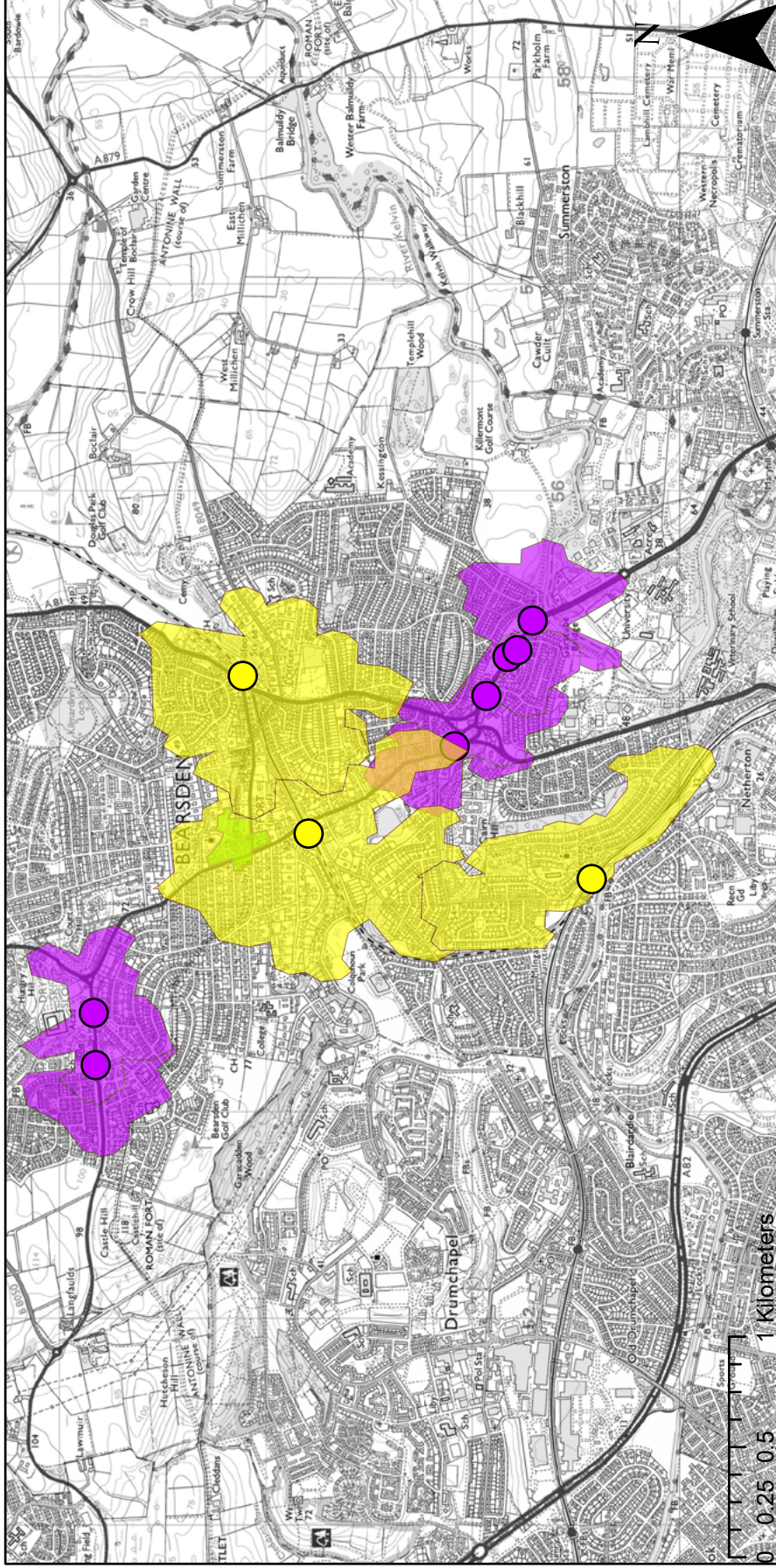

Legend



Town Centre



Bus Stop



Rail Station

5 minutes walking distance (from bus stop with six or more services in peak hours)



5 minutes walking distance (from bus stop with six or more services in peak hours)



10 minutes walking distance (from rail station)



sustainable thriving achieving

**East Dunbartonshire Council**

[www.eastdunbarton.gov.uk](http://www.eastdunbarton.gov.uk)

Reproduced by permission of Ordnance Survey on behalf of HMSO. © Crown copyright and database rights 2018. All rights reserved. East Dunbartonshire Council OS Licence Number 100020774.



# Public Transport Access Areas within Bishopbriggs

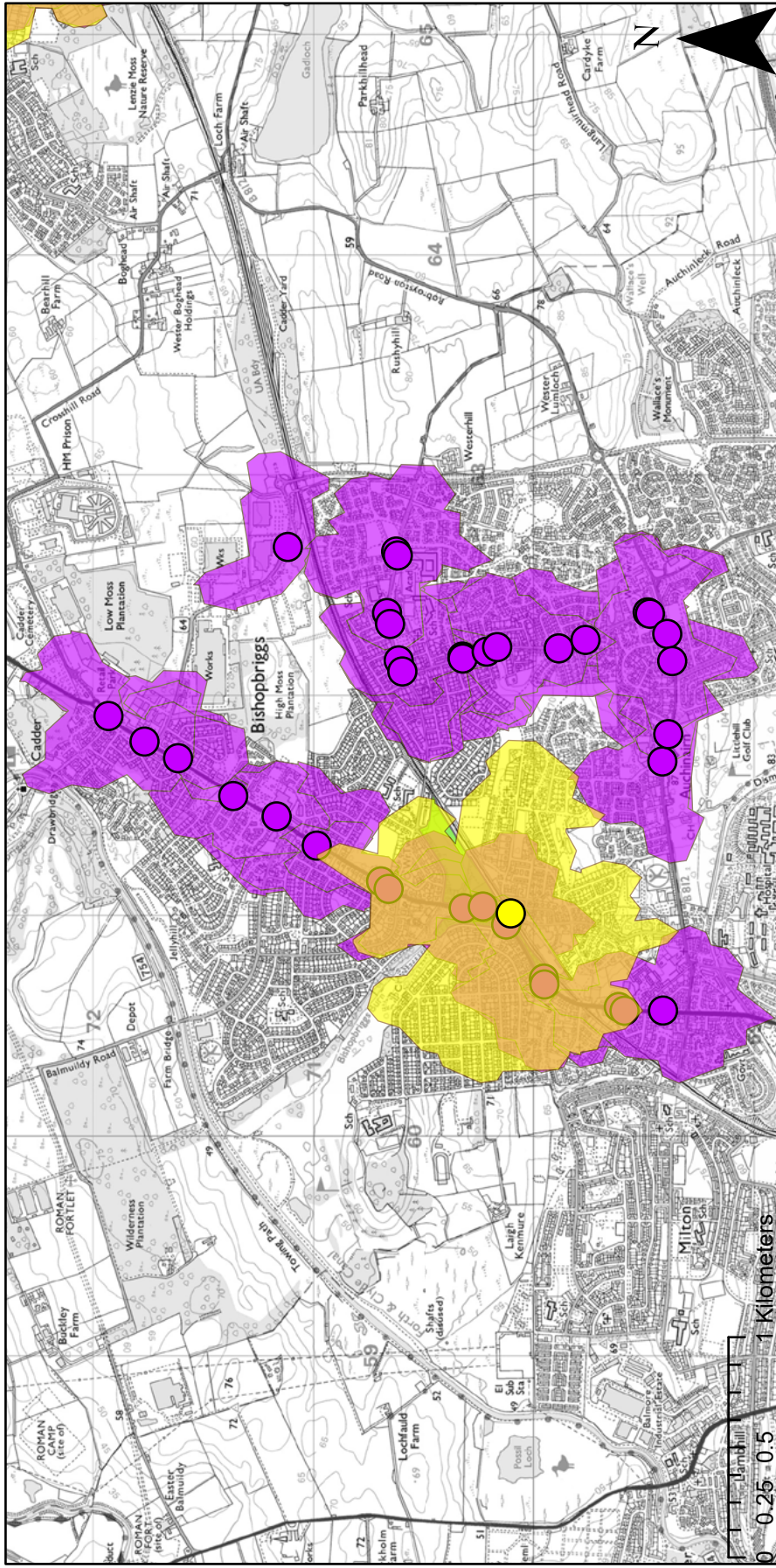

- Legend
- Town Centre
  - Bus Stop
  - Rail Station
  - 5 minutes walking distance (from bus stop with six or more services in peak hours)
  - 10 minutes walking distance (from rail station)

  
**sustainable thriving achieving**  
**East Dunbartonshire Council**  
[www.eastdunbarton.gov.uk](http://www.eastdunbarton.gov.uk)

Reproduced by permission of Ordnance Survey on behalf of HMSO. © Crown copyright and database rights 2018. All rights reserved. East Dunbartonshire Council OS Licence Number 100020774.



# Public Transport Access Areas within Kirkintilloch

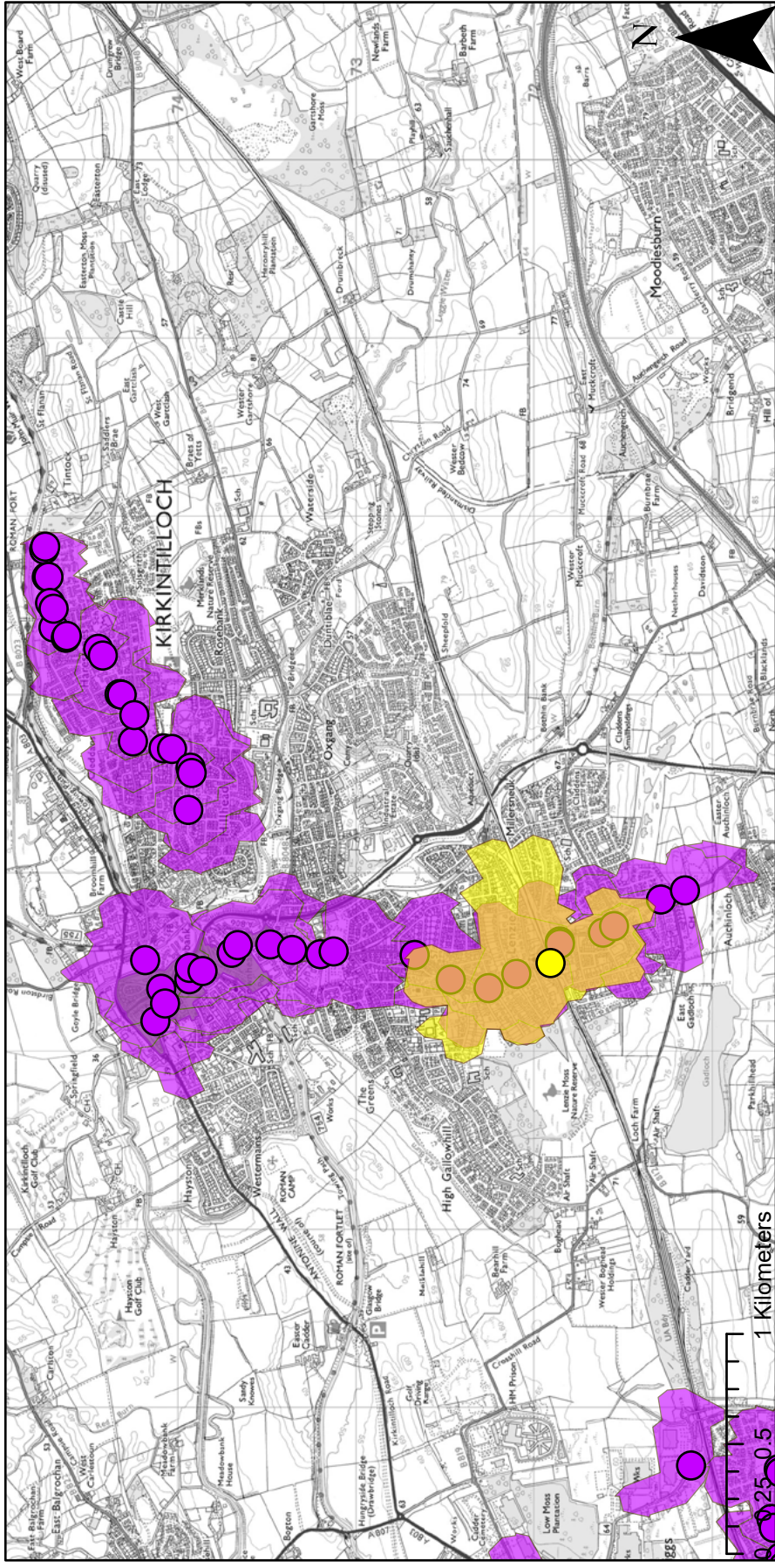

- Legend**
- Town Centre
  - Bus Stop
  - Rail Station
  - 5 minutes walking distance (from bus stop with six or more services in peak hours)
  - 10 minutes walking distance (from rail station)



sustainable thriving achieving  
**East Dunbartonshire Council**  
[www.eastdunbarton.gov.uk](http://www.eastdunbarton.gov.uk)

Reproduced by permission of Ordnance Survey on behalf of HMSO. © Crown copyright and database rights 2018. All rights reserved. East Dunbartonshire Council OS Licence Number 100020774.







# Public Transport Access Areas within East Dunbartonshire

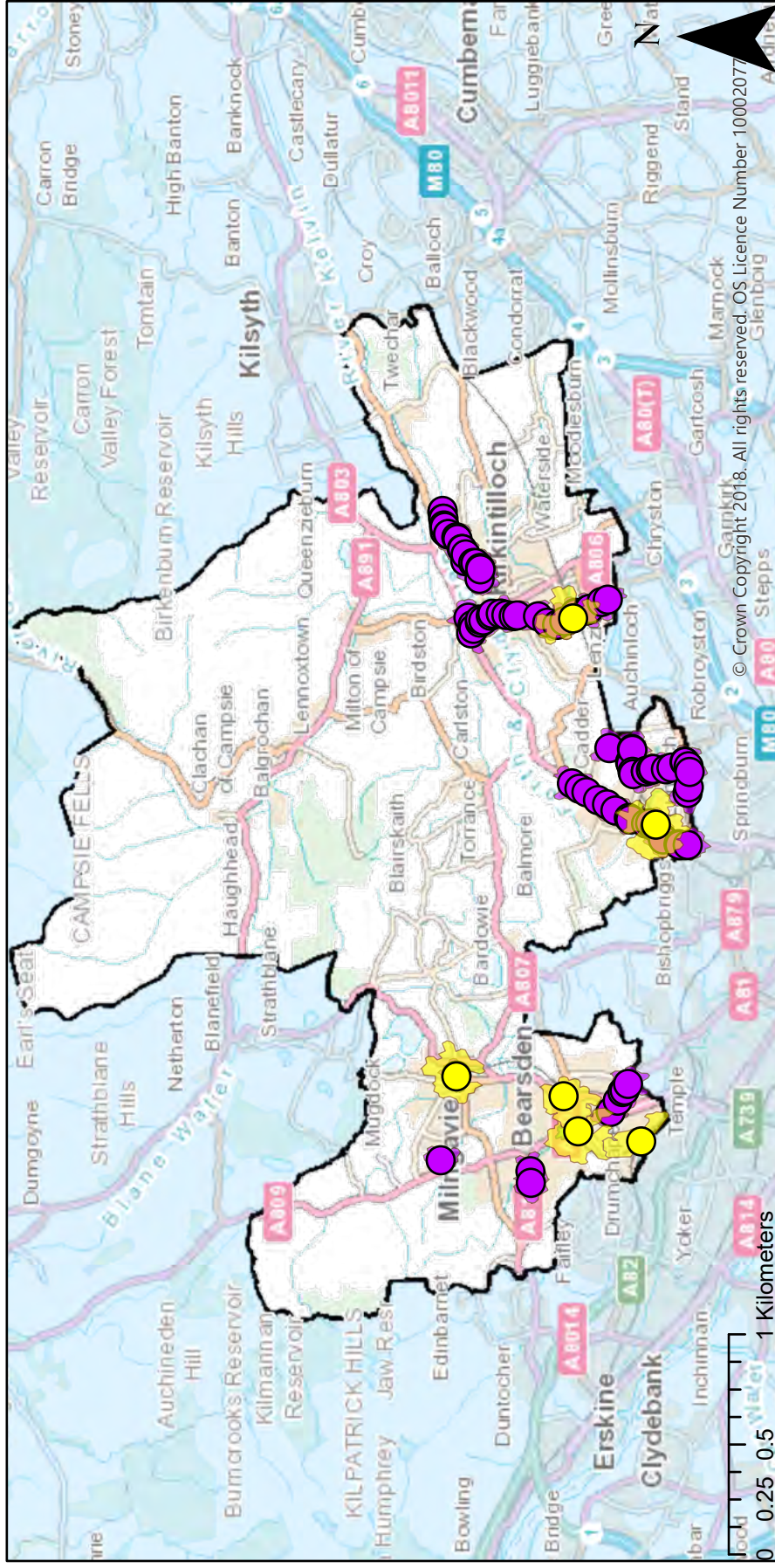

- Legend
- Town Centre
- Bus Stop
- Rail Station
- 5 minutes walking distance (from bus stop with six or more services in peak hours)
- 10 minutes walking distance (from rail station)



sustainable thriving achieving  
**East Dunbartonshire Council**  
[www.eastdunbarton.gov.uk](http://www.eastdunbarton.gov.uk)

Reproduced by permission of Ordnance Survey on behalf of HMSO. © Crown copyright and database rights 2018. All rights reserved. East Dunbartonshire Council OS Licence Number 100020774.

## Appendix 4 – Glossary

**Flats** – A separate and self-contained premises constructed or adapted for use for residential purposes and forming part of a building from some other part of which it is divided horizontally. Flats have to be contained within a dwelling with at least two storeys.

**Retirement Flat** - Purpose built accommodation designed to enable independent living for more active older and retired people. The accommodation will typically have 24 hour emergency call access.

**Detached** – A detached house is a stand-alone residential structure that does not share outside walls with another house or building.

**Semi-detached** – A dwelling attached to another building or dwelling by one common party wall.

**Terraced House** – A house annexed to another house on two sides forming a part of a row of similar houses each with its own frontage to a public road.

**Affordable Home** – A home owned by a government agency or Housing Association where all properties are offered for rent at below market rates. In cases where up to 50% part ownership is proposed then up to 75% an individual property may be sold with the remainder held in perpetuity by the government agency or Housing Association. Otherwise the flats standard will be used for all breaching properties.

**Special Needs** – A dwelling or dwellings that have been specifically designed to meet the needs of people with particular needs.

**Sheltered housing, Resident warden and communal facilities** – This is a group of dwellings where persons within require the aid of an on-site warden facility for semi-independent living with communal facilities.

**Sheltered housing, Remote warden and no communal facilities** – This is a group of dwellings where persons within require the aid of an off-site on-call warden facility for semi-independent living and there are no communal facilities.

**Student Accommodation** – A set of dwellings conforming to the flats definition but which is designed for student communal and primary living location. A letter of comfort will be required from a local college or University.





Other formats and translation

This document can be provided in large print, Braille or audio format and can be translated into other community languages. Please contact the Council's Communications Team at:

East Dunbartonshire Council,  
12 Strathkelvin Place, Southbank, Kirkintilloch, G66 1TJ  
Tel: 0300 123 4510